

BuzziDish

INSTALLATION MANUAL

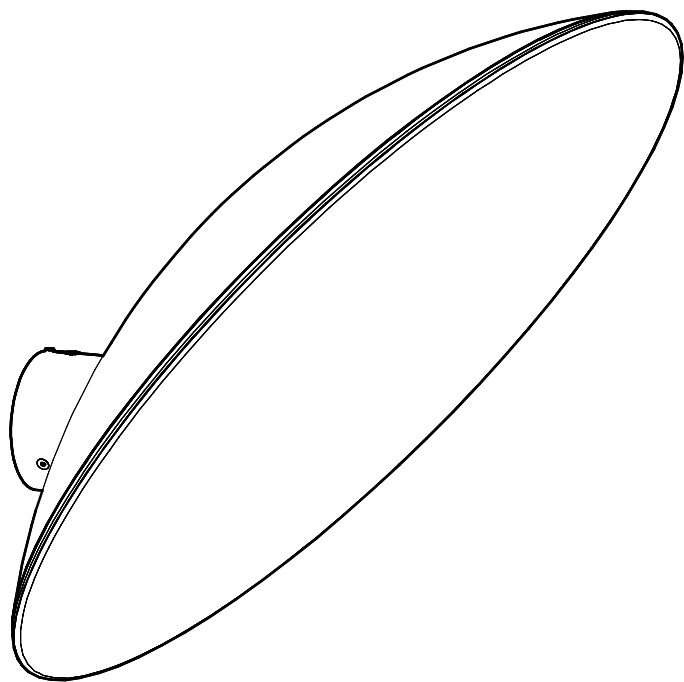

BuzziDish

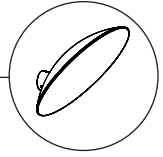

1 PERS. 

Excluded

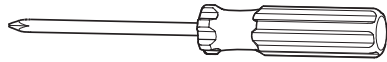
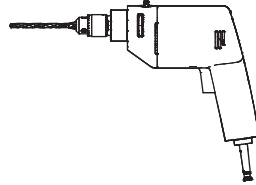

Included

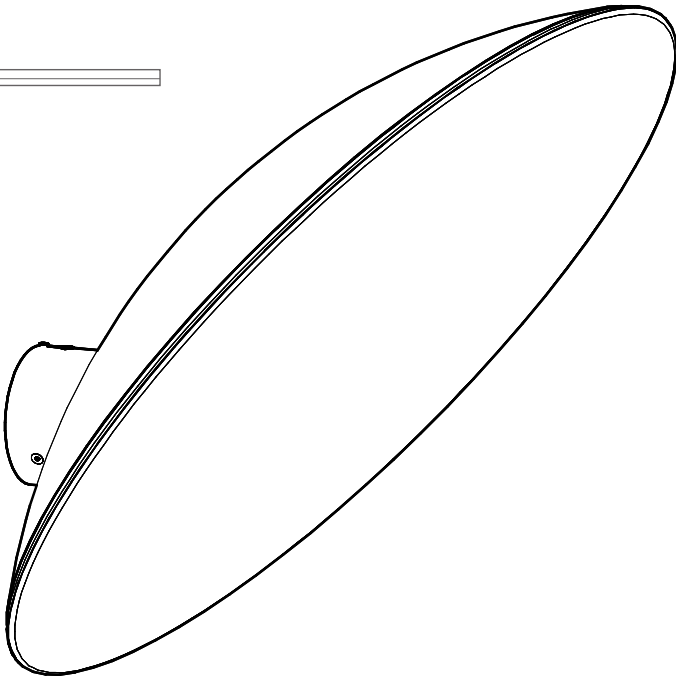

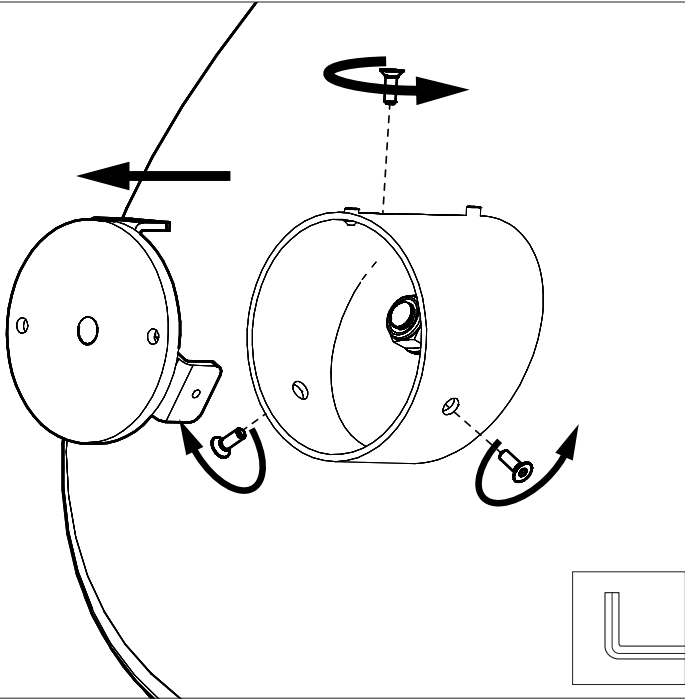
1**2**

The installer is responsible for selecting the right plug and screw, for a secure mounting of the product. Taking into account the weight of the product and the material of the mounting surface.

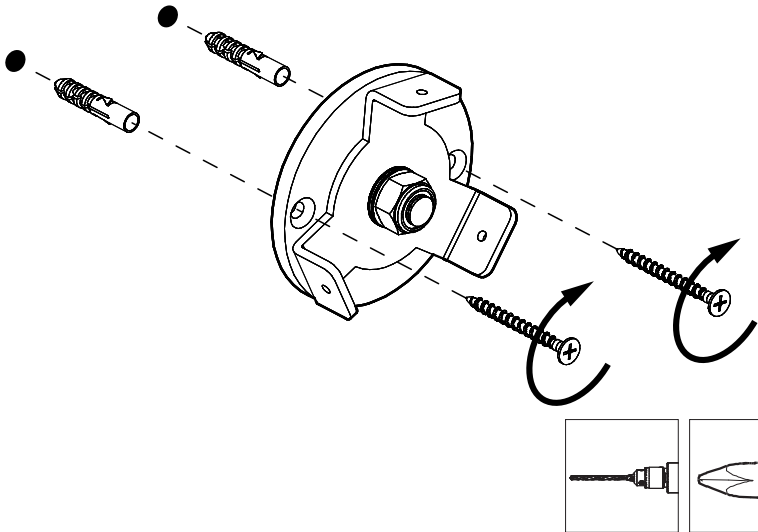

3

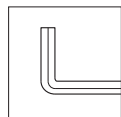
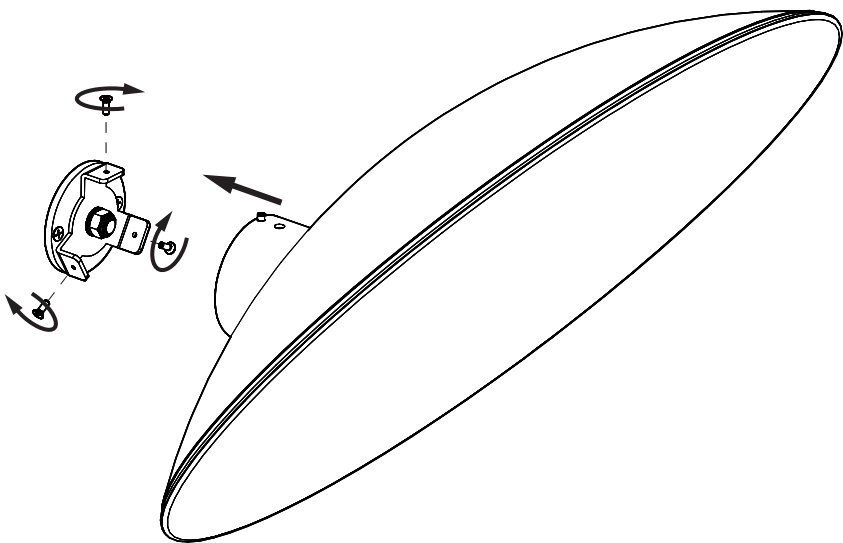

4

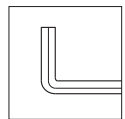
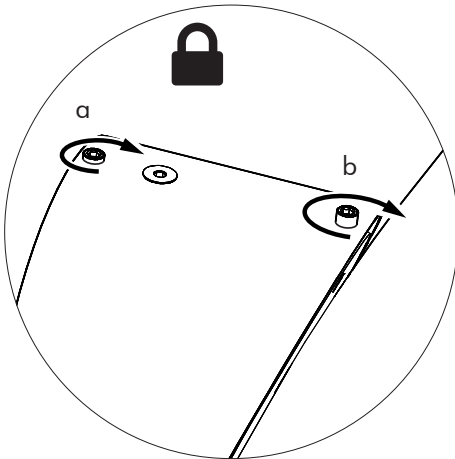
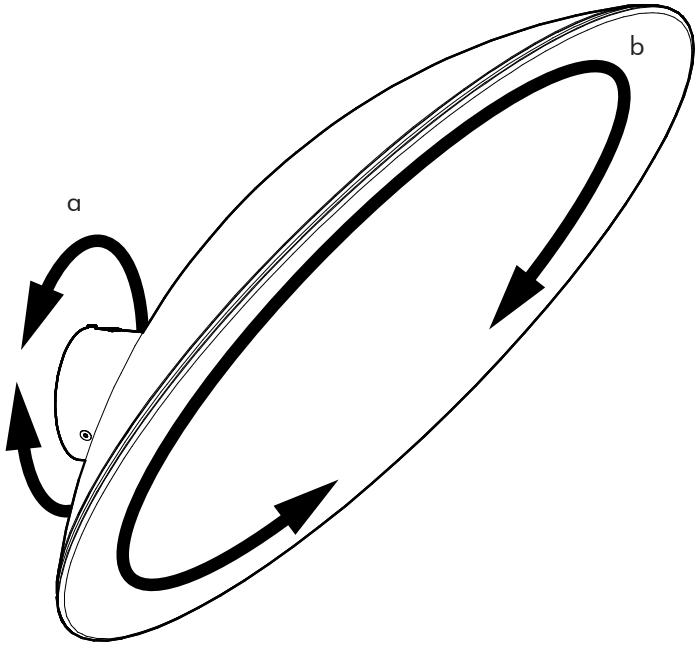

BuzziSpace
Groeningenlei 141
2550 Antwerp, Kontich
Belgium
☎ +32 (0)3 846 10 00
✉ info@buzzi.space
🌐 www.buzzi.space

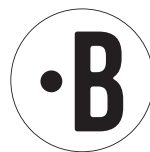

Doc nr.: A-0000006500
Last update: 22/05/2019